

ES Cuadro de control para bombas de natación a contracorriente / SPA / Hidromasaje

EN Control panel for jet-stream pumps / SPA / Whirlpool

FR Coffret de commande pour pompes de nage à contre-courant / SPA / Hydromassage

DE Bedienfeld für Strahlpumpen / SPA / Whirlpool

Conexión eléctrica / Electrical connections / Raccordements électriques / Elektrische Anschlüsse

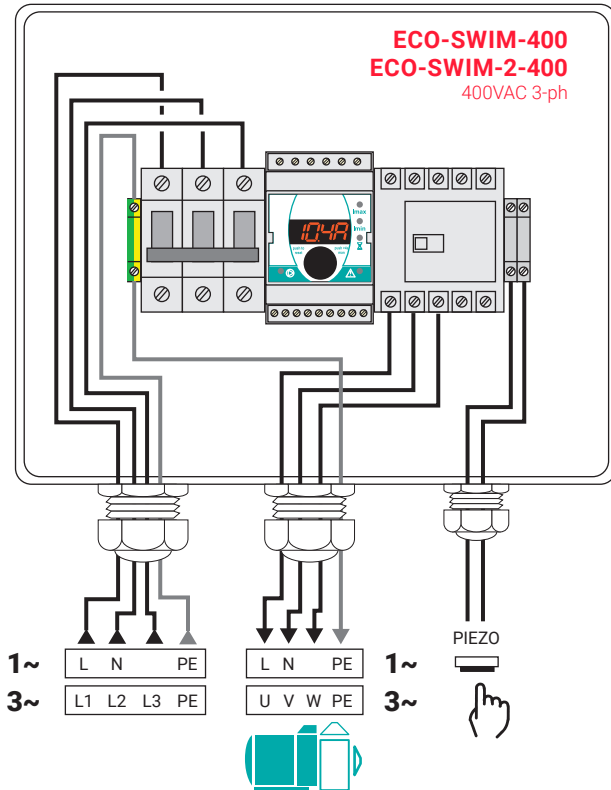
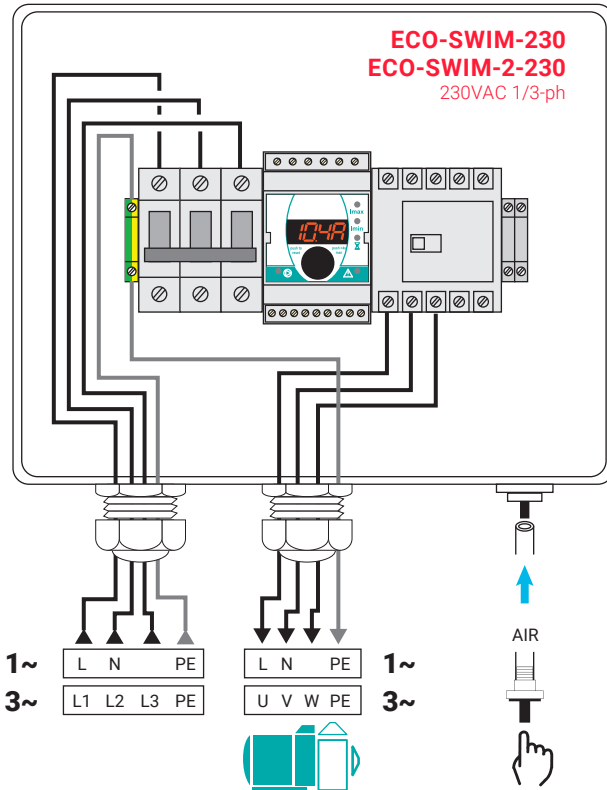

Módulo de control / Control module / Module de commande / Steuerungsmodul

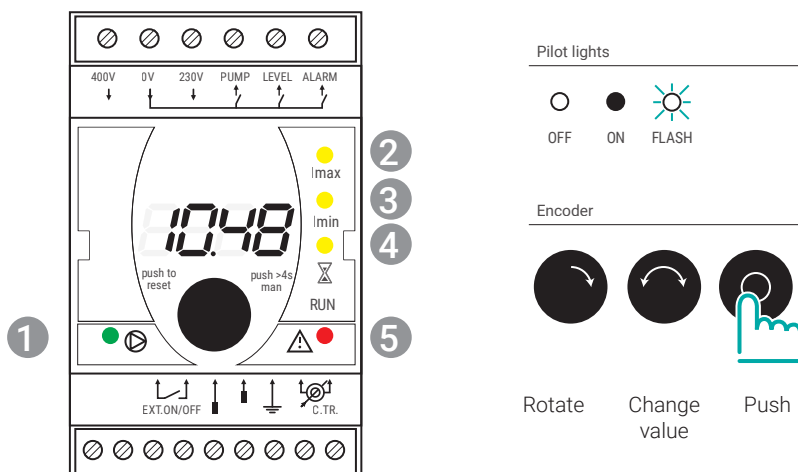

Pilotos:

1. Bomba en marcha.
2. Ajuste de sobrecarga.
3. Ajuste de bajacarga.
4. Ajuste del temporizador.
5. Alarma.

Pilot lights:

1. Pump running.
2. Overload setting.
3. Underload setting.
4. Timer setting.
5. Alarm.

Témoins lumineux:

1. Pompe en marche.
2. Réglage surintensité.
3. Réglage sous-intensité.
4. Réglage minuterie.
5. Alarme.

Kontrollleuchten:

1. Pumpe läuft.
2. Einstellung Überlast.
3. Einstellung Unterlast.
4. Timer-Einstellung.
5. Alarm.

Arranque/parada local de la bomba (módulo)
Local pump start/stop (module)
Marche/arrêt pompe local (module)
Lokaler Pumpenstart/-anschlag (Modul)

Arranque/parada remoto de la bomba
Remote pump start/stop
Marche/arrêt pompe distant
Fern Pumpe Start/Stopp

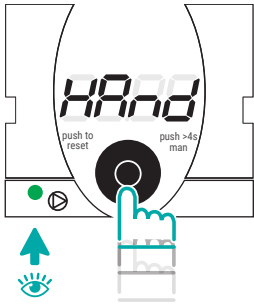

Push >4"
Manual ON

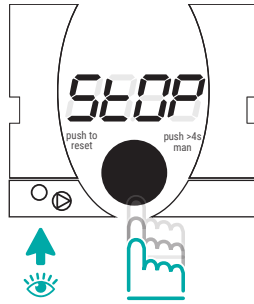

Manual OFF

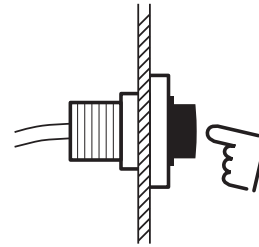

Air switch / Piezo electric switch

Protección térmica de la bomba / Pump thermal protection / Protection thermique de la pompe / Pumpen Wärmeschutz



ES: Durante la primera puesta en marcha, el equipo realizará un ajuste automático de la protección térmica (**Auto-tune**).
 EN: At the first start-up, the controller will perform an auto-calibration of thermal protection (**Auto-tune**).
 FR: A la première mise en route, l'équipement effectue un réglage automatique de la protection thermique (**Auto-tune**).
 DE: Während der ersten Inbetriebnahme des Gerätes führt der controller eine automatische Kalibrierung durch (**Auto-tune**).

Cómo repetir la función **Auto-tune**
How to repeat **Auto-tune**
Comment relancer la fonction **Auto-tune**
So wiederholen Sie **Auto-tune**

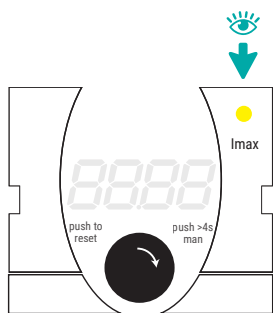

Select parameter

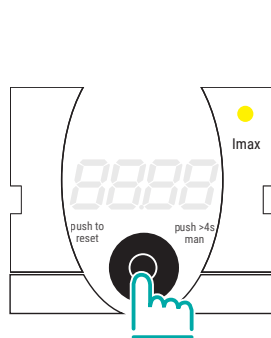

Actual set value

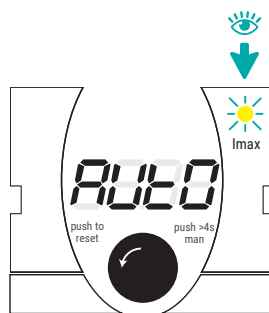

Rotate left

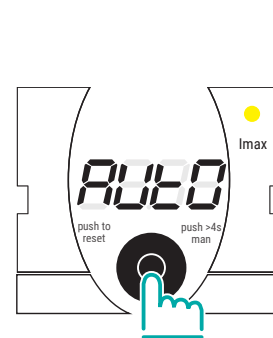

Confirm

Cómo cambiar los parámetros (Imax, Imin, Timer)
How to change the parameters (Imax, Imin, Timer)
Comment changer les paramètres (Imax, Imin, Timer)
Wie man Parameter ändert (Imax, Imin, Timer)

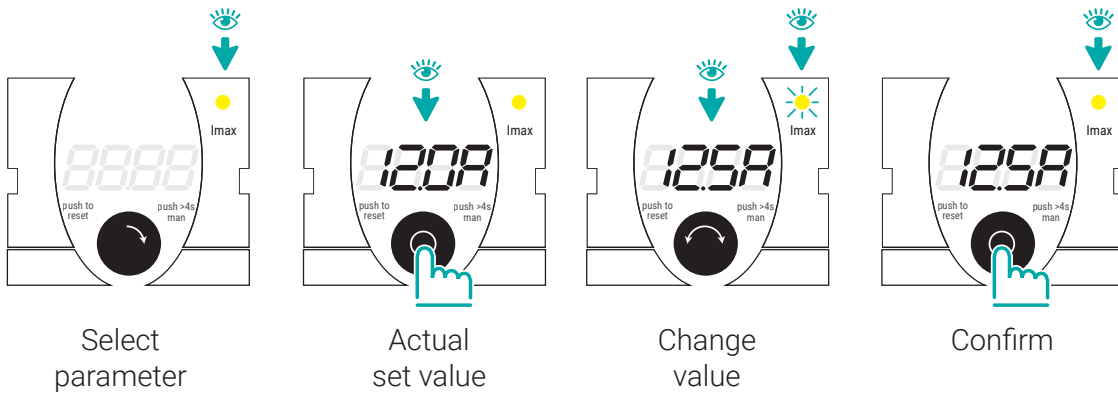

Reinicio de alarmas
Alarms reset
Reset des alarmes
Zurücksetzen Alarm

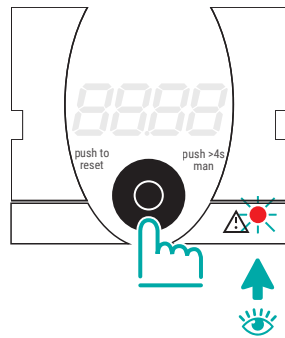

Estado del sistema / System status / État du système / Systemstatus

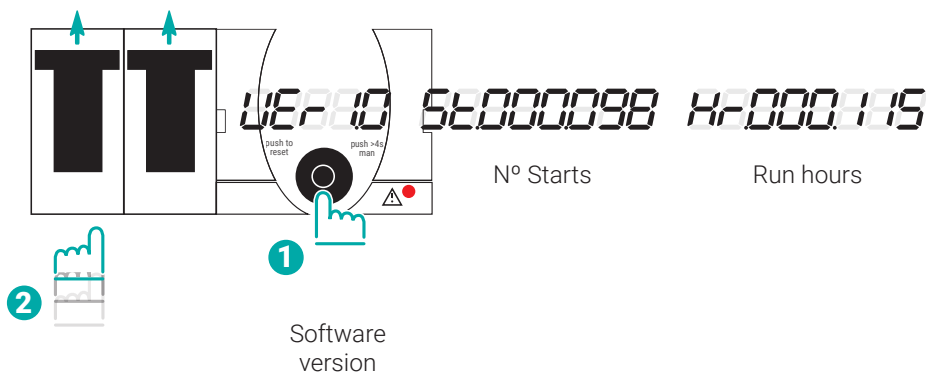

Mensajes de alarmas / Alarm messages / Messages d'alarme / Fehlermeldungen



Sobrecarga / Overload / Surcharge / Überlast



Bajacarga / Underload / Sous-charge / Unterlast

Alimentación	230Vac mono/trifásico o 400Vac trifásico (dependiendo del modelo) - 50/60Hz
Pilotos (LED)	Bomba en marcha, Intensidad máxima, Intensidad mínima, Alarma
Protecciones	Sobrecarga, Bajacarga, Falta de fase, Arranques excesivos
Display	LED 4 dígitos
Interruptor neumático	Para tubo de conexión con \varnothing interior 2,5mm
Interruptor piezoeléctrico	5Vdc, N.O. (impulso)
Salida bomba	12A máximo
Salida alarma (ALARM)	230/400Vac - 5A máximo
Ajuste intensidad máxima	Auto - 0.6...40A (salto en 7s)
Ajuste intensidad mínima	OFF - 0.5...40A (salto en 4s con 20s de inhibición en el arranque)
Ajuste del temporizador	OFF - 1'...240'
Sección máxima en bornas	4mm ² (fuerza) / 2,5mm ² (control)
IP / Temperatura	IP65 / -10°...+55°C
Dimensiones (AxBxC)	235x215x110mm
Versión software	V.1.1
Power supply	230Vac 1/3-ph or 400Vac 3-ph (depending on model) - 50/60Hz
Pilot lights (LED)	Pump running, Maximum current, Minimum current, Main alarm
Protections	Overload, Underload, Phase loss, Excessive starting frequency
Display	4-digit LED
Pump output	12A maximum
Air switch	For connecting tube with internal \varnothing 2,5mm
Piezo switch	5Vdc, N.O. (pulse)
Main alarm output (ALARM)	230/400Vac - 5A maximum
Maximum current setting	Auto - 0.6...40A (trip in 7 s)
Minimum current setting	OFF - 0.5...40A (trip in 4 s with 20 s starting delay)
Timer setting	OFF - 1'...240'
Maximum terminal cross-section	4mm ² (power) / 2,5mm ² (control)
IP / Temperature	IP65 / -10°...+55°C
Dimensions (AxBxC)	235x215x110mm
Software	V.1.1
Tension d'alimentation	230Vac mono/tri ou 400Vac tri (suivant modèle) - 50/60Hz
Témoins lumineux (LED)	Pompe en marche, Intensité maxi, Intensité mini, Alarme
Protections thermiques	Surcharge, Sous-charge, Manque de phase, Démarrages successifs
Display	LED 4 digits
Interrupteur pneumatique	Pour tube de connexion avec \varnothing intérieur 2,5mm
Interrupteur piézoélectrique	5Vdc, N.O. (impulsion)
Sortie alimentation pompe	12A maximum
Report d'alarme (ALARM)	230/400Vac - 5A maximum
Réglage protection surintensité	Auto - 0.6...40A (déclenchement en 7 s)
Réglage protection sous-intensité	OFF - 0.5...40A (temps d'amorçage de 20 s puis déclenchement en 4 s)
Réglage minuterie	OFF - 1'...240'
Section de raccordement	4mm ² (puissance) / 2,5mm ² (commande)
IP / Température	IP65 / -10°...+55°C
Dimensions (AxBxC)	235x215x110mm
Version logiciel	V.1.1
Energieversorgung	230Vac 1/3-ph oder 400Vac 3-ph (nach Ausführung) - 50/60Hz
Kontrollleuchten (LED)	Pumpe ein, Max. Stromaufnahme, Min. Stromaufnahme, Alarm
Schutz	Überlast, Unterlast, Phasenausfall, Hochfrequenz Starts-Erkennung
Anzeige	4-stellige LED
Pumpenleistung	12A maximum
Luftschalter	Für Verbindungsschläuche mit Innen- \varnothing 2,5mm
Piezo-Schalter	5Vdc, N.O. (impuls)
Hauptalarmausgang (ALARM)	230/400Vac - 5A maximum
Maximale Stromeinstellung	Auto - 0.6...40A (trip in 7 s)
Minimale Stromeinstellung	OFF - 0.5...40A (trip in 4 s with 20 s starting delay)
Timer-Einstellung	OFF - 1'...240'
Maximaler Anschlussquerschnitt	4mm ² (power) / 2,5mm ² (control)
IP / Temperatur	IP65 / -10°...+55°C
Abmessung (AxBxC)	235x215x110mm
Software	V.1.1

